

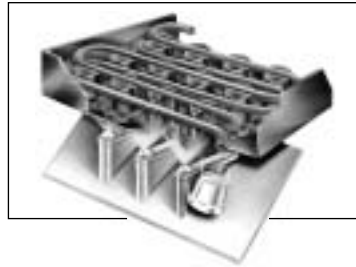

- AC 46
- AC 56
- AC 86
- AC 106
- AC 126
- AC 176
- AC 206
- AC 226



Available as optional
KITLEGSEXT000



Spray bar quick disconnect



Patented
anti-scale
system

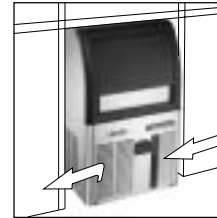

Storage bin antibacterial
pouch & holder

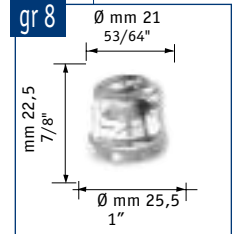

ACS 56

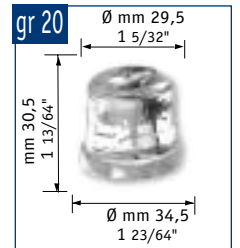

ACM 56

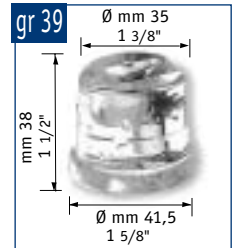

ACL 56



Proximity
Condenser air filter



Routine maintenance
alarm
Front ON - OFF switch



Hygienic scoop
holder



Storage bin antibacterial
pouch & holder

**Automatic
Gourmet-Cube
Ice Machine**

**Machine
Automatique
à Glaçons
Gourmet**

**Automatischer
Gourmetkegel-
eisbereiter**

**Màquina
Automàtica
Fabricadora de
Cubitos Gourmet**

**Produttore
Automatico
di Ghiaccio a
Cubetti Gourmet**

Model	Temperature Range	Production Capacity (Cubes per Hour)						Power	Dimensions (mm)	Dimensions (inches)	Weight
		10°:10°C	21°:15°C		[kg]	[lbs]	N°*				
ACS 56 AS	+	25	55	3125	22.5	49.5	2810	230/50/1	386x600x693/828	15"x23"x27"/32"	R 134 a
ACM 56 AS	+	31,5	69	1575	29	64	1450	230/50/1	386x600x693/828	15"x23"x27"/32"	R 134 a
ACM 56 WS	+	32,5	71	1625	29	64	1450	230/50/1	386x600x693/828	15"x23"x27"/32"	R 134 a
ACL 56 AS	+	31	68	795	28.5	63	730	230/50/1	386x600x693/828	15"x23"x27"/32"	R 134 a

*Estimate number of medium/large size gourmet cubes.
Standard legs 135 mm high included. Leg extension 60 mm high available as code no. KITLEGSEXT000.
Optional: PWD System.

www.scotsman-ice.com
www.scotsman-ice.it

2

Years Warranty
Ans de Garantie
Jahre Garantie
Años de Garantía
Anni di Garanzia

Subject to certain limitations and exclusions
Assujettie aux limites et exclusions prescrites
Abhängig von Bestimmten Einschränkungen und Ausnahmen
Sujeta a algunas limitaciones y exclusiones
Soggetta ad alcune limitazioni ed esclusioni



AC 56

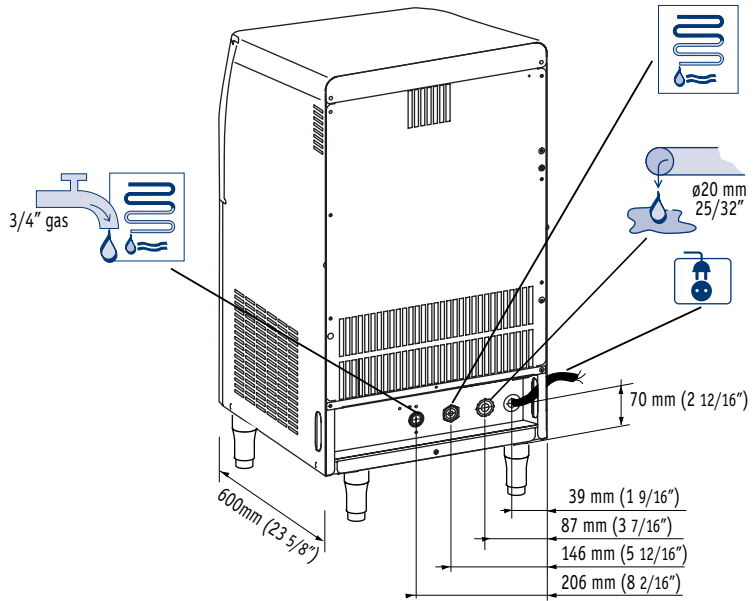
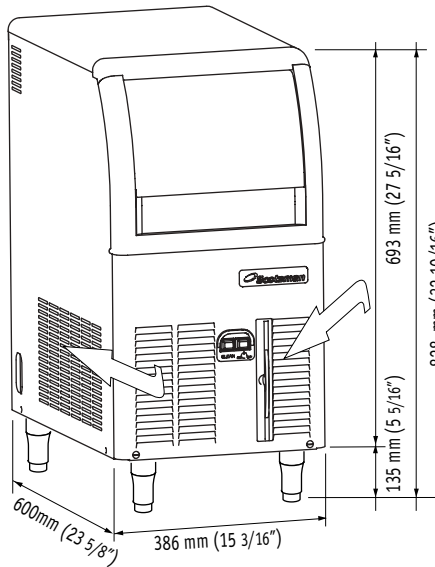

Model	Refrigerant	Capacity [Btu/h]	Power [W]	Ice Output [kg]	Power [W]	FUSE [A]	Energy [kWh]	Water [L/h]	Water [gal/h]	Weight [kg]	Weight [lbs]	Weight [kg]	Weight [lbs]
ACS 56 AS	R404A	2730	800	1,5	400	10	7.6	3.1	0.82	36	80	43	95
ACM 56 WS	R404A	2730	800	1,5	400	10	7.6	3.7	0.99	36	80	43	95
ACM 56 AS	R404A	2730	800	1,5	400	10	7	20.2	5.34	36	80	43	95
ACL 56 AS	R404A	2730	800	1,5	400	10	7.6	4.2	1.1	36	80	43	95

AC 56 AIR COOLED



°C	50°	60°	70°	90°	
10°	31.5	30	28.5	25.5	kg
50°	69	66	63	56	lbs
21°	30.5	29	27.5	24.5	kg
70°	67	64	60	54	lbs
32°	27	25.5	24	21	kg
90°	59	56	53	46	lbs
38°	25.5	24	22.5	19.5	kg
100	56	53	49	43	lbs



Machine requires voltage indicated on rating name plate. Failures caused by improper voltage are not considered factory defects. Scotsman products are not designed for outdoor installation. Extended periods of operation at temperatures exceeding the above limitations constitutes misuse under the terms of Scotsman Limited Warranty, resulting in a loss.

AC 56 WATER COOLED



°C	50°	60°	70°	90°	
10°	32.5	31	29.5	26.5	kg
50°	71	68	65	58	lbs
21°	30.5	29	27.5	24.5	kg
70°	67	64	60	54	lbs
32°	30	28.5	27	24	kg
90°	66	63	59	53	lbs
38°	29	27.5	26	23	kg
100	64	60	57	51	lbs



La machine doit être raccordée conformément au voltage indiqué sur la plaque signalétique. Les éventuels dégâts causés par un non respect de cette consigne ne peuvent être considérés comme des défauts de fabrication. Les machines à glace Scotsman ne sont pas conçues pour être utilisées à l'extérieur. Le fonctionnement prolongé à des températures supérieures ou inférieures aux limites ci-dessus sont considérées comme une mauvaise utilisation dans le cadre de la garantie Scotsman.

Der Eisbereiter benötigt eine Stromspannung gemäß Geräde-Typenschild. Störungen oder Ausfälle, durch den Betrieb mit falscher Stromspannung sind keine Fabrikationsfehler und fallen nicht unter Garantie. Scotsman Eisbereiter sind nicht für die Installation im Freien geeignet. Der längere Betrieb bei Temperaturen über den obigen Grenzwerten ist eine falsche Anwendung und bedeutet den Verlust der Garantieleistung.

Los requerimientos eléctricos de la máquina están indicados en la placa de características. Los daños causados por voltajes inadecuados no son considerados defectos de fábrica. La máquinas de hielo Scotsman, no están diseñadas para trabajar a la intemperie. Largos periodos de funcionamiento a temperaturas que excedan de las limitaciones indicadas, constituyen maltrato de acuerdo con las observaciones de Scotsman.

La macchina richiede il voltaggio indicato sulla targhetta di identificazione. Danni causati da voltaggi diversi non sono considerati difetti di produzione. I prodotti Scotsman non vanno utilizzati all'aperto. Un prolungato periodo di utilizzo al di fuori delle temperature indicate non è consentito e causa l'automatico decadere della garanzia.



Minimum

10°C (50°F)

5°C (41°F)

-10%

1 BAR

14 psi



Maximum

40°C (104°F)

35°C (95°F)

+10%

5 BAR

70 psi



Scotsman[®]
Ice Systems

The one the world relies on.

Certified ISO 9001:2000

USA, Canada, Latin America

Scotsman Ice Systems USA
775 Corporate Woods Parkway
Vernon Hills, IL 60061
Ph: (+1) 847 215-4550
Fax: (+1) 847 913-9844
customer.service@scotsman-ice.com

Europe

Scotsman Europe-Frimont S.p.A.
Via Puccini, 22
20010 Pogliano (Milano) Italy
Ph: (+39) 02-93960208
Fax: (+39) 02-93960201
scotsman.europe@frimont.it

Asia and Pacific

Scotsman Ice Systems-Frimont S.p.A. (R.O.)
627A Aljunied Road-#04-04 Biztech Centre
Singapore 389842
Ph: (+65) 6738 5393
Fax: (+65) 6738 1959
scotsice@singnet.com.sg

China

Scotsman Ice Systems
(Shanghai) Co., Ltd
Room 405-407 Jing'an China Tower
1701 West Beijing Road-200040 Shanghai
Ph: (+86) 21-62476056-Fax: (+86) 21-62476126
scotsmansh@online.sh.cn

Middle East & N. Africa

Scotsman Ice Systems Dubai Office
P.o. Box 21648
Sharjah - U.A.E.
Mobile: Ph: (+971) 505505980
Fax: (+971) 6-5654063
scotsman@eim.ae

South Africa

Scotsman Ice Systems SA (PTY) Ltd.
10, Rhodes Street - Kensington B
P.o. Box 44 - Riverclub 2149
Ph: (+27) 11-7898400
Fax: (+27) 11-7898411
scotsman@telkomsa.net